



ON Semiconductor®
SSG Division

Battery Fuel Gauge IC (LC709203F)

Battery Fuel Gauge IC for 1-Cell Lithium-ion (Li+)

Application Note

Ver2.00

Battery Fuel Gauge IC (LC709203F)

Application Note

1. Introduction
2. Features
3. Pin Assignment
4. Performance Specifications
 - 4.1 Application Field
 - 4.2 Electrical Characteristics
 - 4.3 Communication Protocol
 - 4.4 Note on Electrical Characteristics
 - 4.5 About matters that require attention in the board making
 - 4.6 Example of Standard Use of the Application
 - 4.7 About Alarm Function
5. Schematic
6. Evaluation Board
7. Board Layout
8. Bill of materials
9. Performance Data
 - 9.1 Discharge1: Current Charge (250mA → 1500mA)
 - 9.2 Discharge2: Current Charge (1100mA → 500mA)
 - 9.3 Discharge3: Pulse Discharge (1250mA ↔ 1750mA)
 - 9.4 Discharge4: Neglect (750mA, 20min Neglect, 750mA)
 - 9.5 Discharge5: Standby Current (8mA)
 - 9.6 Discharge6: Constant Watt (3.76W)

1. Introduction

The LC709203F is an IC that measures the remaining power level of 1-cell lithium-ion (Li+) batteries used for portable equipment etc.

This product reduces fuel gauge errors with a unique correction technology during measurement of battery temperature and voltage.

This technology has inherently high precision without the need for an external sense

2. Features

- Delivering the industry’s leading accuracy of $\pm 3\%$ for the battery fuel gauge detection allows high accuracy estimation of the remaining operating time.
- Quiescent is a very low $15\mu\text{A}$.
- Since a high-cost external resistor for current detection is not required, both BOM cost and substrate size are reduced.

3. Pin Assignment

VDFN8 (4.0×3.0)

Top view

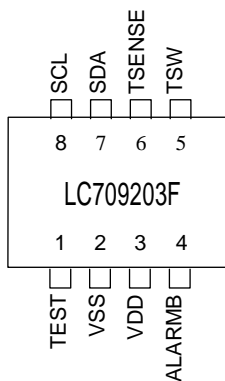

WLP9 (1.76×1.60)

Bottom view

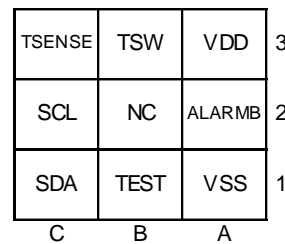

VDFN8	WLP9	Pin Name	I/O	Description
1	1B	TEST	I	Test pin *Connect to V _{SS} .
2	1A	V _{SS}	-	Connect to the - terminal of the battery.
3	3A	V _{DD}	-	Connect to the + terminal of the battery.
4	2A	ALARMB	O	Alert indication. An active low output used to indicate specified condition thresholds have been met. *When you do not use an alert function, please connect with V _{SS} .
5	3B	TSW	O	Battery temperature reading control pin *Set high when reading in the temperature, held low at other times.
6	3C	TSENSE	I	Battery temperature analog voltage input pin
7	1C	SDA	I/O	I ² C data pin
8	2C	SCL	I/O	I ² C clock pin
-	2B	NC	-	Not used pin. *Recommend to connect to V _{SS} .

4. Performance Specifications

4.1. Application Field

This product is ideal for mobile devices such as smart-phones, mobile phones, digital still cameras, digital video cameras, MP3 players, and portable DVD players that are powered by 1-cell lithium-ion batteries or include a battery pack, and require a display to indicate the battery's remaining power levels.

4.2. Electrical Characteristics

Parameter	Conditions	Specification			Unit	
		VDD[V]	Min	Typ		Max
Consumption current	Normal Mode	2.5 to 4.5		15	26	μ A
	Accurate ECO Mode	2.5 to 4.5		2	4.5	
	Sleep Mode	2.5 to 4.5		0.2	4	
Voltage measurement accuracy	Ta = +25°C	3.6	-7.5		+7.5	mV/cell
	Ta = -20°C to +70°C	2.5 to 4.5	-20		+20	

4.3. Communication Protocol

Communication protocol type : I2C

Frequency : to 400kHz

IC address : 0x16 (It becomes "0001011X" when you write a binary, because the slave address is 7 bits. [X]=Rd/Wr.)

Bus Protocols

- S : Start Condition
- Sr : Repeated Start Condition
- Rd : Read (bit value of 1)
- Wr : Write (bit value of 0)
- A : ACK (bit value of 0)
- N : NACK (bit value of 1)
- P : Stop Condition
- CRC-8 : Slave Address to Last Data (CRC-8-ATM : ex.3778mV : 0x16,0x09,0x17,0xC2,0x0E → 0x86)
- | |
|--|
| |
|--|

 : Master-to-Slave
- | |
|--|
| |
|--|

 : Slave-to-Master
- ... : Continuation of protocol

Read Word Protocol

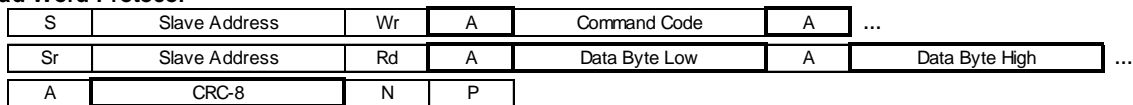

*When you do not read CRC-8, there is not the reliability of data. CRC-8-ATM ex : (5 bytes) 0x16,0x09,0x17,0xC2,0x0E → 0x86

Write Word Protocol

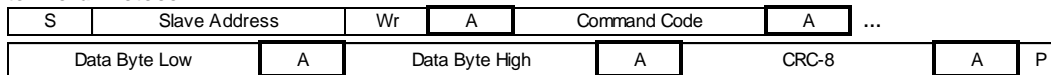

*When you do not add CRC-8, the Written data (Data byte Low/High) become invalid.

CRC-8-ATM ex : (4 bytes) 0x16, 0x09, 0x55, 0xAA → 0x3B

Command Code	Slave Functions	Stats	Range	Unit	Initial Value
0x06	Thermistor B	R/W	0x0000 to 0xFFFF	B	0x0D34
0x07	Initial RSOC	W	0xAA55	Value	-
0x08	Cell Temperature	R	0x0000 to 0xFFFF (Thermistor Mode)	0.1°K (0.0°C = 0x0AAC)	0x0BA6 (25°C)
		W	0x09E4 to 0x0D04 (Via I2C)		
0x09	Cell Voltage	R	0x0000 to 0xFFFF	mV	-
0x0A	Current Direction	R/W	0x0000 or 0x0001 or 0xFFFF	0x0001 : Charge Mode 0x0000 : Auto Mode 0xFFFF : Discharge Mode	0x0000
0x0B	Adjustment Pack Appli	R/W	0x0000 to 0xFFFF	Value	-
0x0C	Adjustment Pack Thermistor	R/W	0x0000 to 0xFFFF	Value	0x001E
0x0D	RSOC	R	0x0000 to 0x0064	%	-
	Set RSOC	W			
0x0F	Indicator To Empty	R	0x0000 to 0x03E8	Value	-
0x11	IC Version	R	0x0000 to 0xFFFF	Version	-
0x12	Change Of The Parameter	R/W	0x0000 or 0x0001	Please refer to a low er list	0x0000
0x13	Alarm Low RSOC	R/W	0x0000 to 0x0064	% (activate under)	0x0008
0x14	Alarm Low Cell Voltage	R/W	0x0000 to 0xFFFF	mV (activate under)	0x0000
0x15	IC Power Mode	R/W	0x0000 to 0x0002	0x0000 : Nomal Mode 0x0001 : Accurate ECO 0x0002 : Sleep Mode	-
0x16	Status Bit	R/W	bit 0 : Thermistor Mode bit 1 to 15 : Reserved (fix 0)	0 : disable 1 : enable	0x0000
0x1A	Number Of The Parameter	R	0x0301 or 0x0504	Please refer to a low er list	-

	Type Of The Battery	Number Of The Parameter	Change Of The Parameter
LC709203F-01	Normal Voltage3.8V, Charge Voltage 4.35V	0x0301	0x0000
	Normal Voltage3.7V, Charge Voltage 4.2V		0x0001
LC709203F-04	ICR18650-26H (SAMSUNG)	0x0504	0x0000
	UR18650ZY (Panasonic)		0x0001

RSOC = Relative State Of Charge

0xXXXX = Hexadecimal notation

(Note)

Initialization from Host :

- The IC will initialize reading the battery temperature until Initialization sequence with serial port is executed. (Please see EVB manual for sequences.)

Control from Host :

- The Remaining State of Charge (RSOC) is normally read periodically.
- To read temperature the part will need a sequence of instructions and then returned to RSOC reading.

4.4. Note on Electrical Characteristics

1. Since I²C address is fixed ensure that other devices do not use the same address.
2. IC's initialization time is within 80ms from power on.
3. If initialized (Initial Relative State of Charge) the IC by I2C, start reading battery value after 2ms.
4. If power is applied to VDD and VSS the battery value will remain stable regardless of the state of the Enable/Disable registers.

4.5. Layout and schematic

1. Connect the capacitor (1μF) between VDD and VSS as near the terminal of the IC as possible.
2. When you do not use an alarm function simply connect the alarm terminal to VSS without a pullup resistor.

Example of Standard Use of the Application

Samples of the Battery Fuel Gauge IC (LC709203F) can measure the battery value with high accuracy. However, if there is no calibration there may be an error of ±5 to 10% when flowing large-current (about 0.5C) depending on the state of charge of the battery.

Please contact ON Semiconductor prior to part qualification for a review of the intended design and to determine if a calibrated part is needed.

4.6. About Alarm Function

If the Battery's remaining charge drops lower than the set value or lower than the set voltage The output at AlarmB will be pulled low by the open drain internal FET.

- Please examine the chart below concerning this function. (initial setting is 8%)

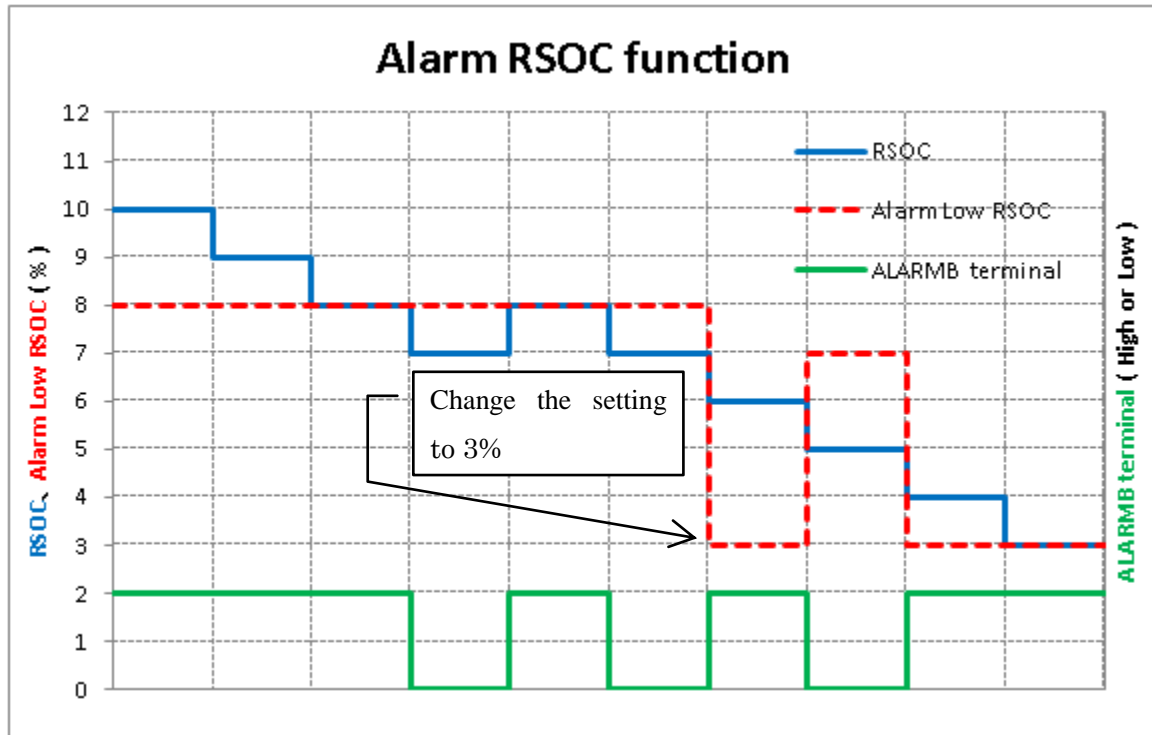

5. Schematic

Figure1. When temperature detection function is not utilized:

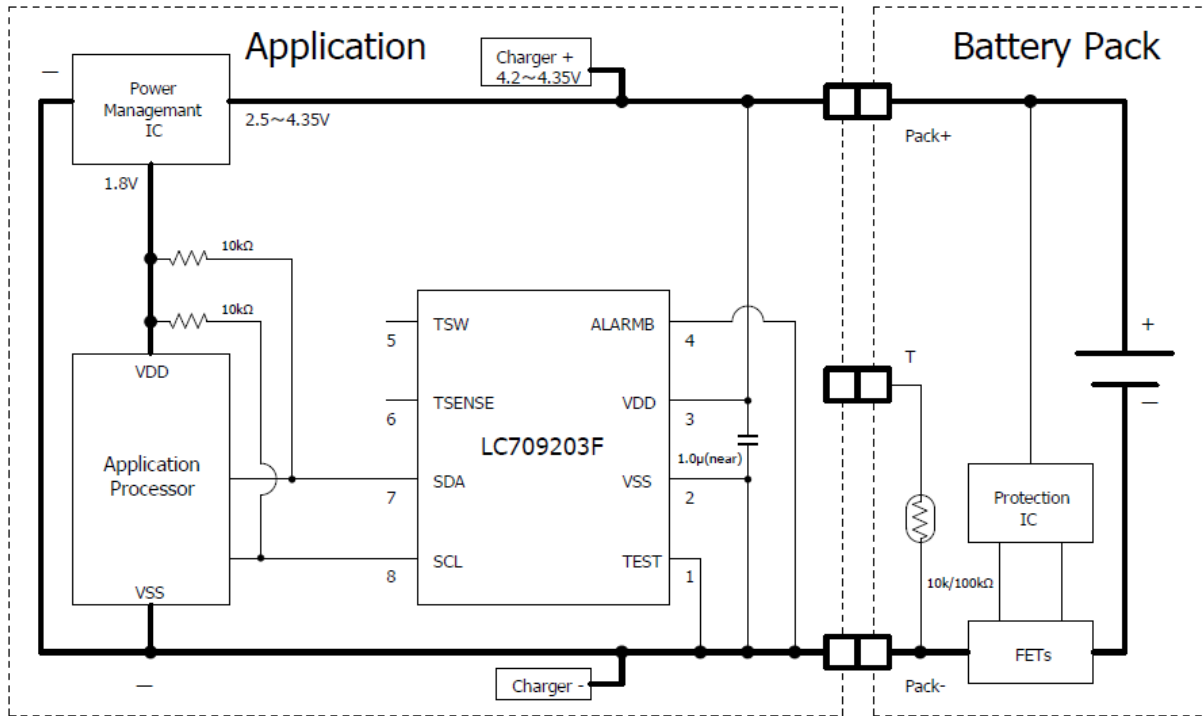
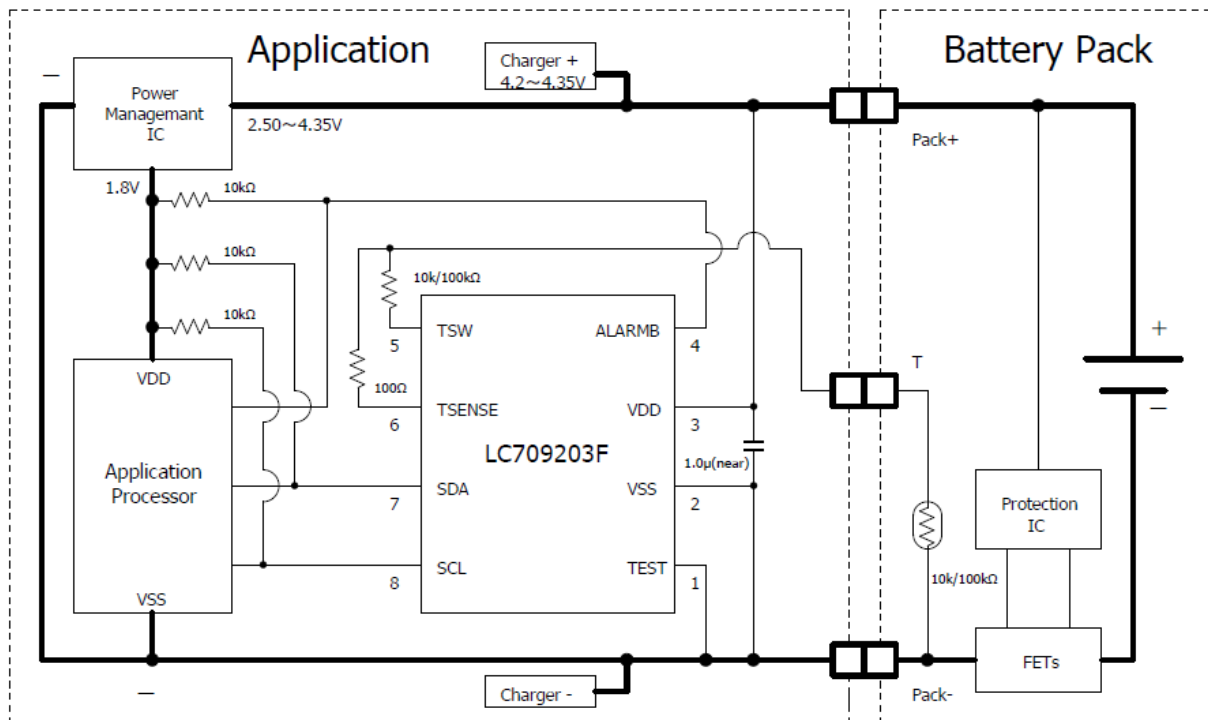

Figure2. When the temperature detection function is in use:



6. Evaluation Board

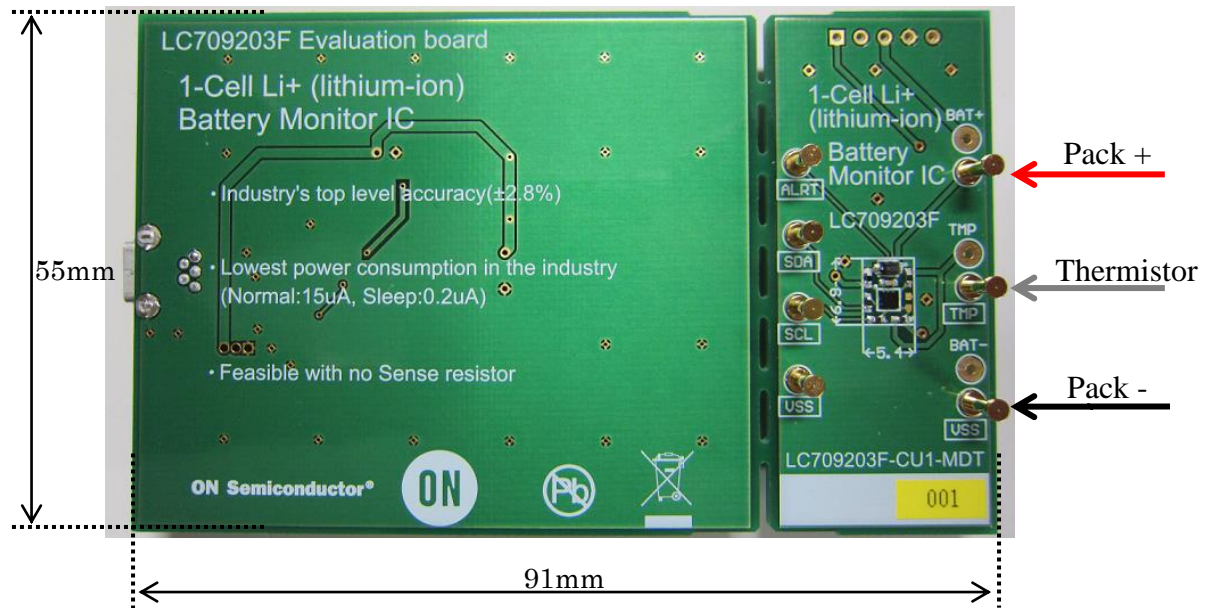

Figure3. LC709203F(WLCSP9) Evaluation Board

(Note) Please refer to a LC709203F Evaluation kit Manual for the evaluation board operation.

7. Board Layout

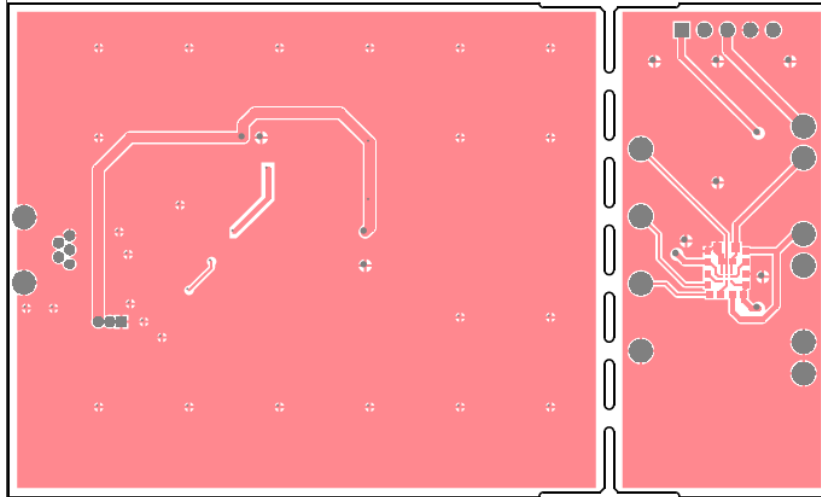

Figure5. IC Side Layout

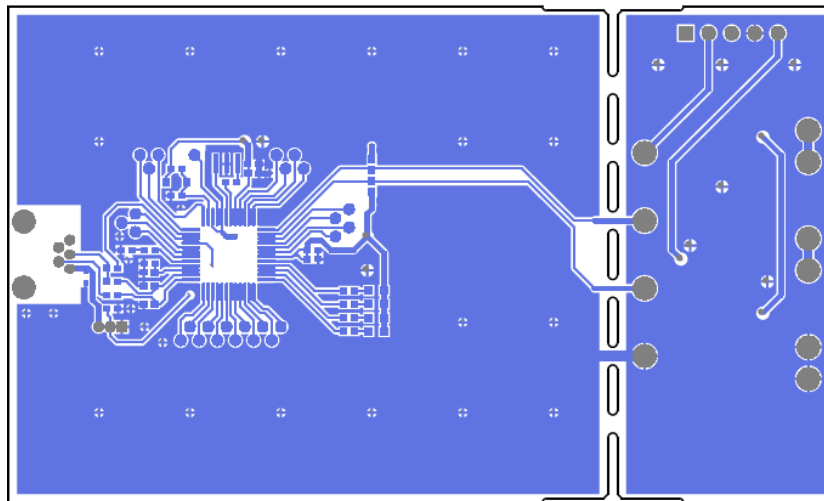

Figure6. Bottom Layout

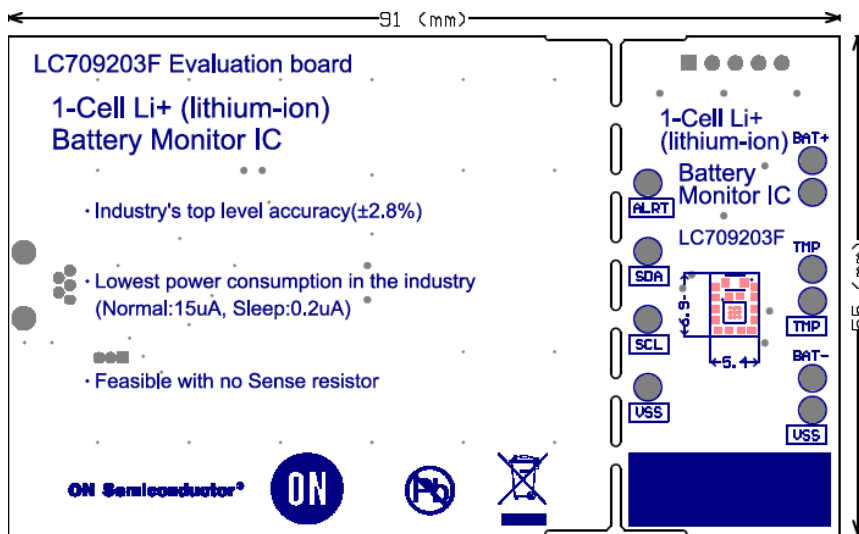

Figure7. Board Size

8. Bill of materials

Designator	Quantity	Description	scription1	Value	Value1	Tolerance	Footprint	Manufacturer	Part Number	bsitution Allow	Lead Free
ALRT, SCL, SDA, TMP2, VDD, VSS, VSS1	7	Terminal	Dip				ST-2-2	MAC8	ST2-2	Yes	Yes
BAT+, BAT-,TMP1	3	Terminal	Dip				ST-2-2	MAC8	NM	Yes	Yes
C1	0	Capacitor	SMD	*u	16V	10%	1005	Murata	GRM155B31CXXXKA12#	Yes	Yes
C2	1	Capacitor	SMD	1u	16V	10%	1005	Murata	GRM155B31C105KA12#	Yes	Yes
C3, C4	2	Capacitor	SMD	5p	50V	±0.25pF	1005	Murata	GRM1535C1H5R0CDD5#	Yes	Yes
C5	1	Capacitor	SMD	2.2u	10V	±10% or ±15%	1005	Murata or TDK	GRM155B31A225KE95# or C1005X5R1A225K050BC	Yes	Yes
C6, C8, C10, C12	4	Capacitor	SMD	0.1u	25V	±10%	1005	Murata	GRM155B31E104KA87#	Yes	Yes
C7	1	Capacitor	SMD	2.2u	10V	±10%	1005	Murata	GRM155B31A225KE95#	Yes	Yes
C9, C11	2	Capacitor	SMD	1500p	50V	±10%	1005	Murata	GRM15XB11H152KA86#	Yes	Yes
CF1	1	Murata ceralock	SMD	12MHz			X-CSTCE	Murata	CSTCE12M0GH5L	Yes	Yes
CN1	1	Molex 54819-0519					Molex_54819-0519	Molex	54819-0519		
CN2	0	LANDφ0.8mm					LAND3pin				
D1	1	Switching Diode	SMD				SOD-323	ON Semiconductor	MMDL6050T1G	No	Yes
IC1	1	WLP9	SMD				WLP9	ON Semiconductor	LC709203F	No	Yes
IC2	1		SMD				SQFP48(7X7)	ON Semiconductor		No	Yes
LED1, LED2, LED3, LED4	4	LED	SMD				LED1608	unknown	RED	Yes	Yes
R1, R2, R4	3	Resistor	SMD	100	0.063W	±5%	1005	KOA	RK73B1ETTD101J	Yes	Yes
R3	1	Resistor	SMD	100k	0.063W	±5%	1005	KOA	RK73B1ETTD104J	Yes	Yes
R5, R7	2	Resistor	SMD	33	0.063W	±5%	1005	KOA	RK73B1ETTP330J	Yes	Yes
R6	1	Resistor	SMD	10k	0.063W	±1%	1005	KOA	RK73B1ETTP103F	Yes	Yes
R16, R17	2	Resistor	SMD	10k	0.063W	±5%	1005	KOA	RK73B1ETTP103J	Yes	Yes
R8	1	Resistor	SMD	1.5k	0.063W	±5%	1005	KOA	RK73B1ETTP152J	Yes	Yes
R9	1	Resistor	SMD	100	0.063W	±5%	1005	KOA	RK73B1ETTP101J	Yes	Yes
R10	1	Resistor	SMD	100k	0.063W	±5%	1005	KOA	RK73B1ETTP104J	Yes	Yes
R11	1	Resistor	SMD	15k	0.063W	±5%	1005	KOA	RK73B1ETTP153J	Yes	Yes
R12, R13, R14, R15	4	Resistor	SMD	3k	0.063W	±5%	1005	KOA	RK73B1ETTP302J	Yes	Yes
RD1	1	Resistor	SMD	330	0.063W	±5%	1005	KOA	RK73B1ETTP331J	Yes	Yes
ZD1	1	Zener Diode	SMD				SOD-323	ON Semiconductor	MM3Z5V6T1G	No	Yes
ZD2	1	SMD	SMD				SOD-523	ON Semiconductor	MM5Z6V2ST1G	No	Yes

9. Performance Data

9.1. Discharge1: Current Charge (250mA → 1500mA)

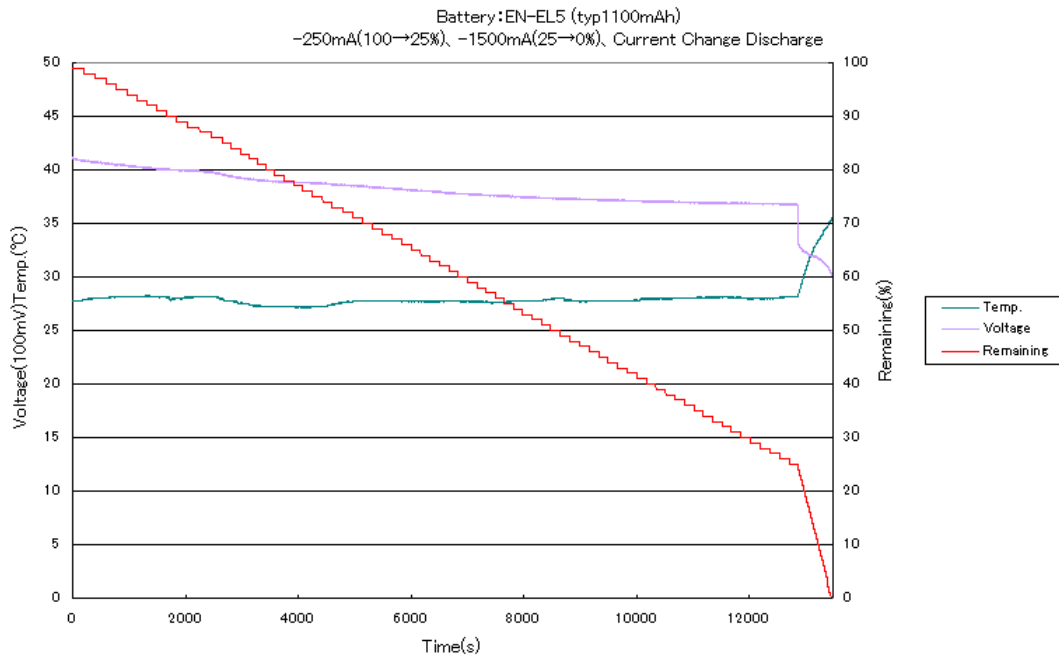

*After discharging the battery (with 250mA load) from 100% down to 25%, the load is increased to 1500mA. Battery remaining is still linear after discharge current is changed.

9.2. Discharge2: Current Charge (1100mA → 500mA)

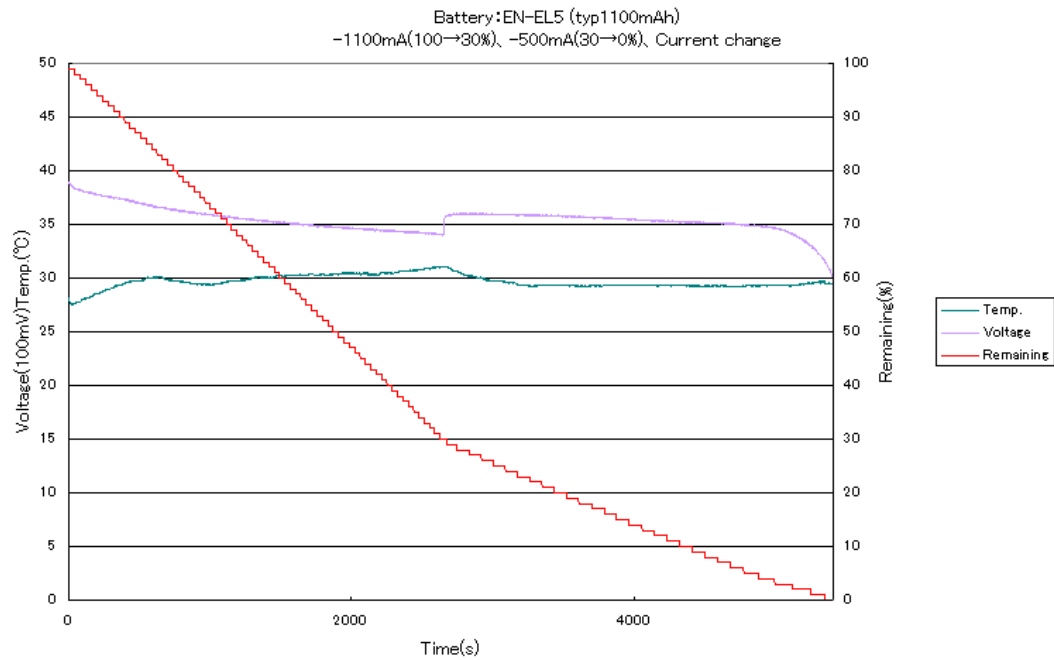

*After discharging the battery (with 1100mA load) from 100% down to 30%, the load is decreased to 500mA. Battery remaining is still linear after discharge current is changed.

Discharge3: Pulse Discharge (1250mA ↔ 1750mA)

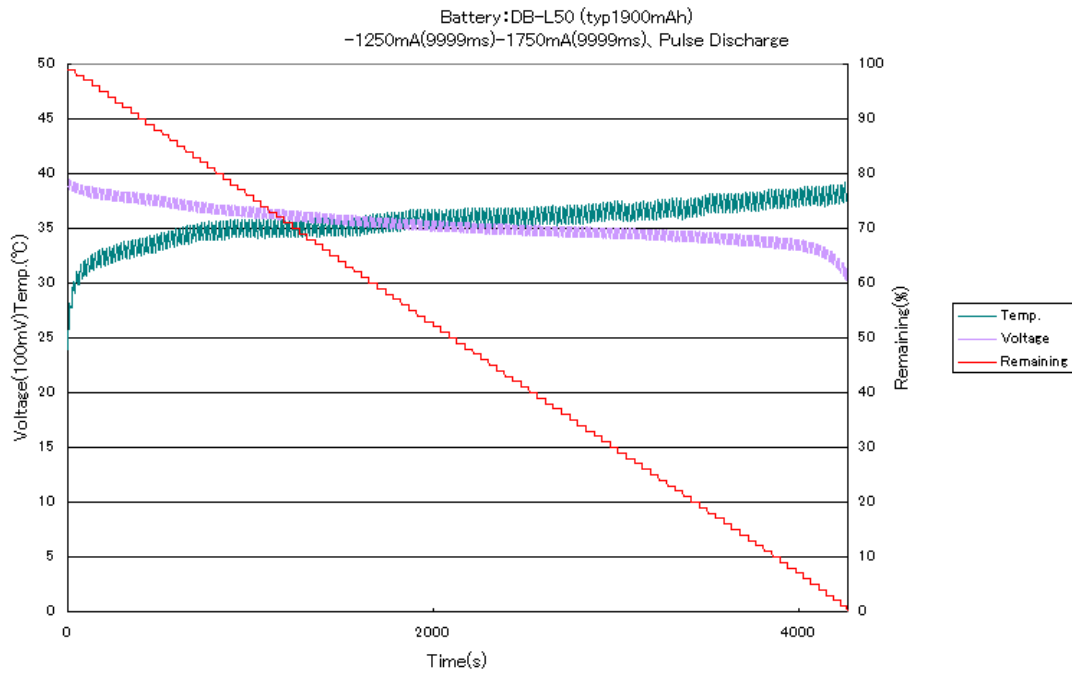

*Pulse discharging by alternating discharge current values of 1250mA and 1750mA every 10sec. battery remaining is linear for 100% to 0%.

9.3. Discharge4: Neglect (750mA, 20min Neglect, 750mA)

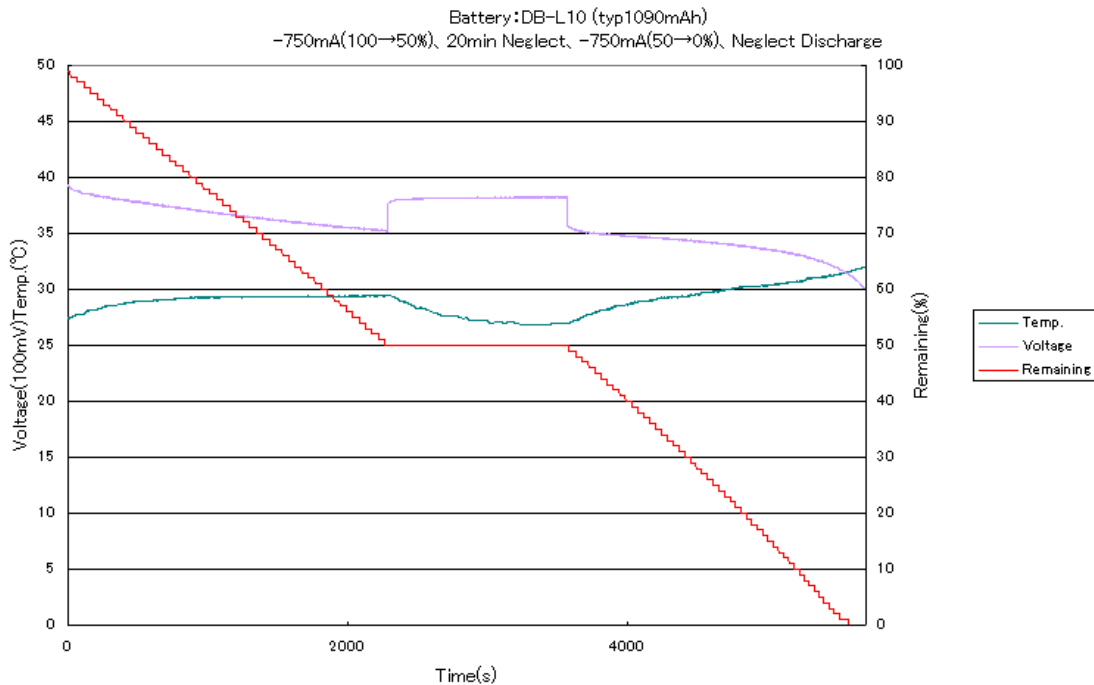

*Discharging battery from 100% to 50% with 750mA load. After removing load for 20min, discharge the battery with 750mA again. Battery remaining is still linear. When load is removed the graph shows the battery's voltage increases and at the point of re-discharge, battery voltage decreases.

Discharge5: Standby Current (8mA)

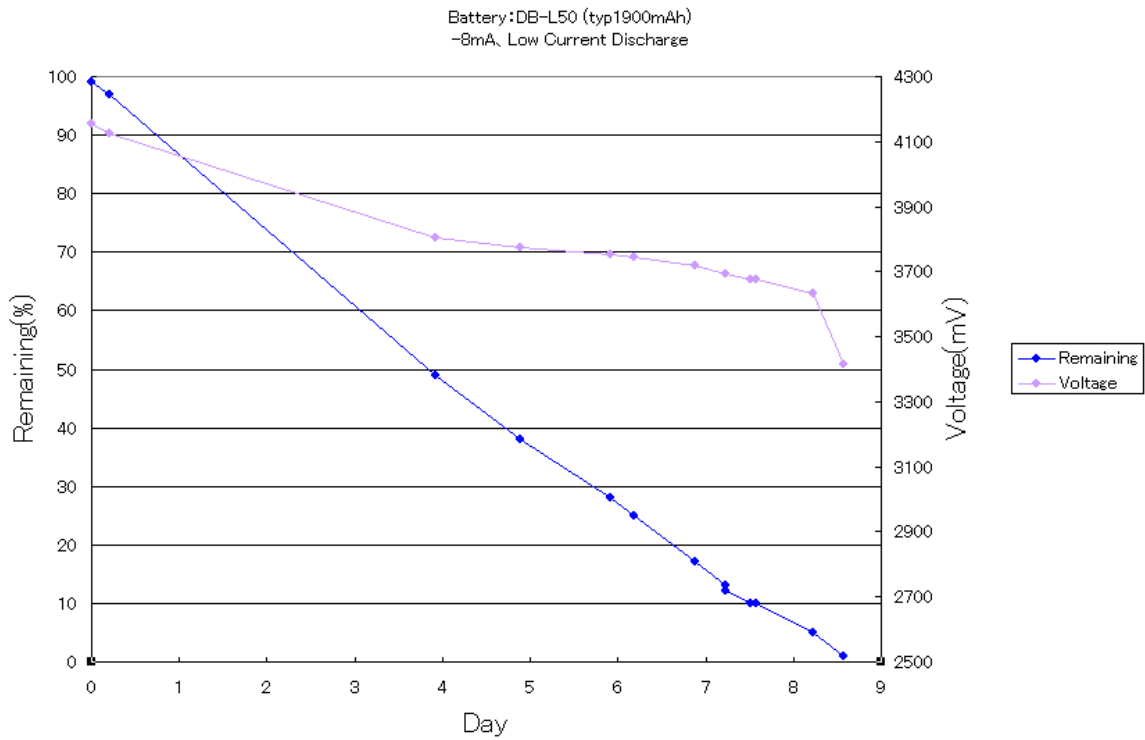

*Assuming the part is in stand-by and the load is 8mA.

Even at the very little current flowing, the graph is still linear.

9.4. Discharge6: Constant Watt (3.76W)

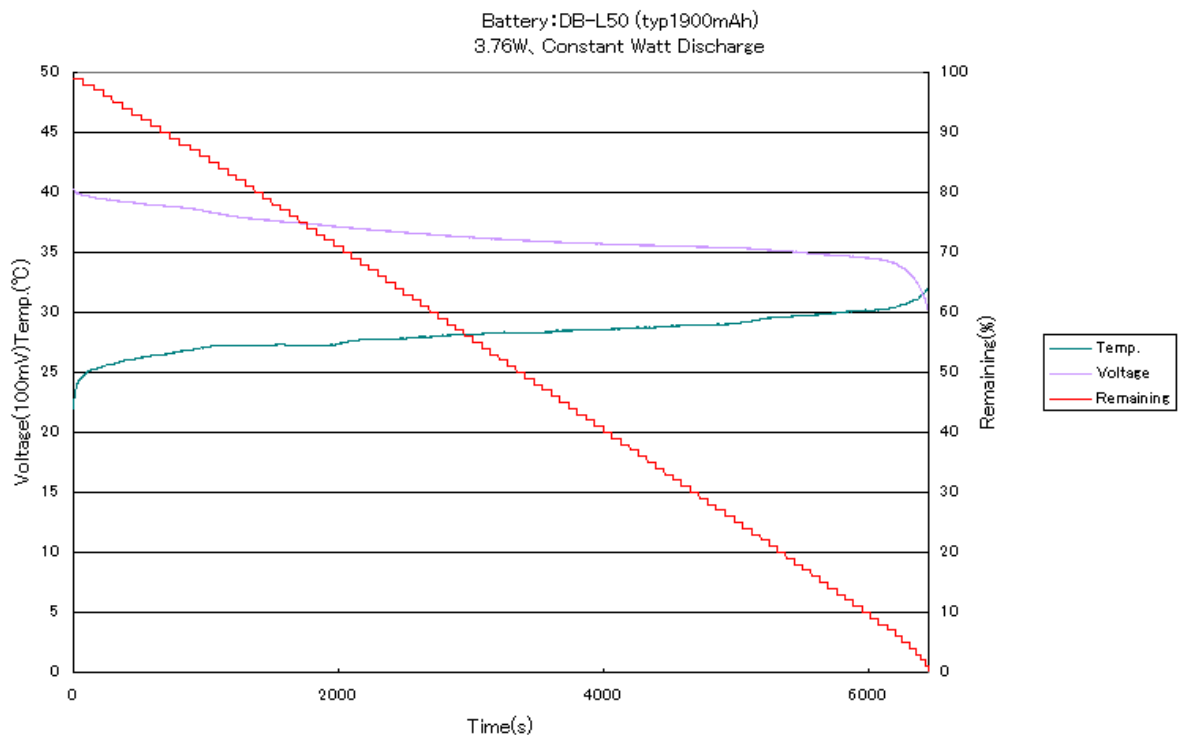

*Increasing current as the battery's voltage decreases to discharge at the same power (3.76W). In this case, battery remaining is still linear.

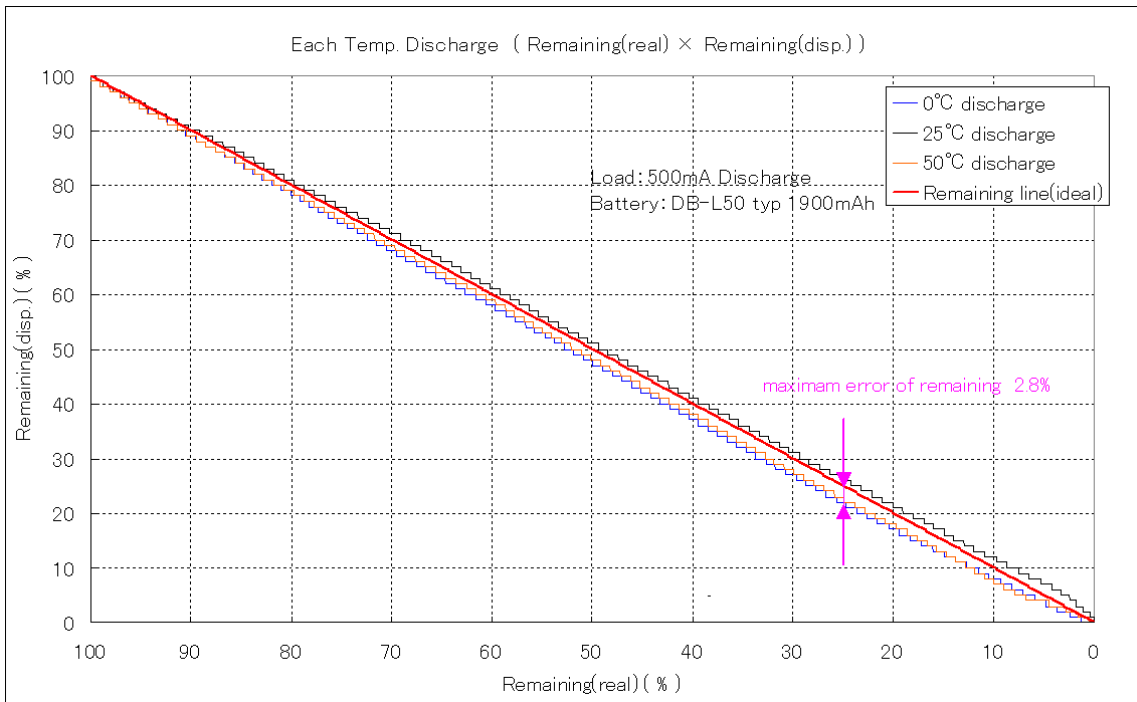

*Testing discharging of 100% to 0%. Discharging current is 500mA. Temperature is room temp., 0 degree Celsius and 50 degree Celsius. Red line shows the ideal line and maximum error is the 2.8%.

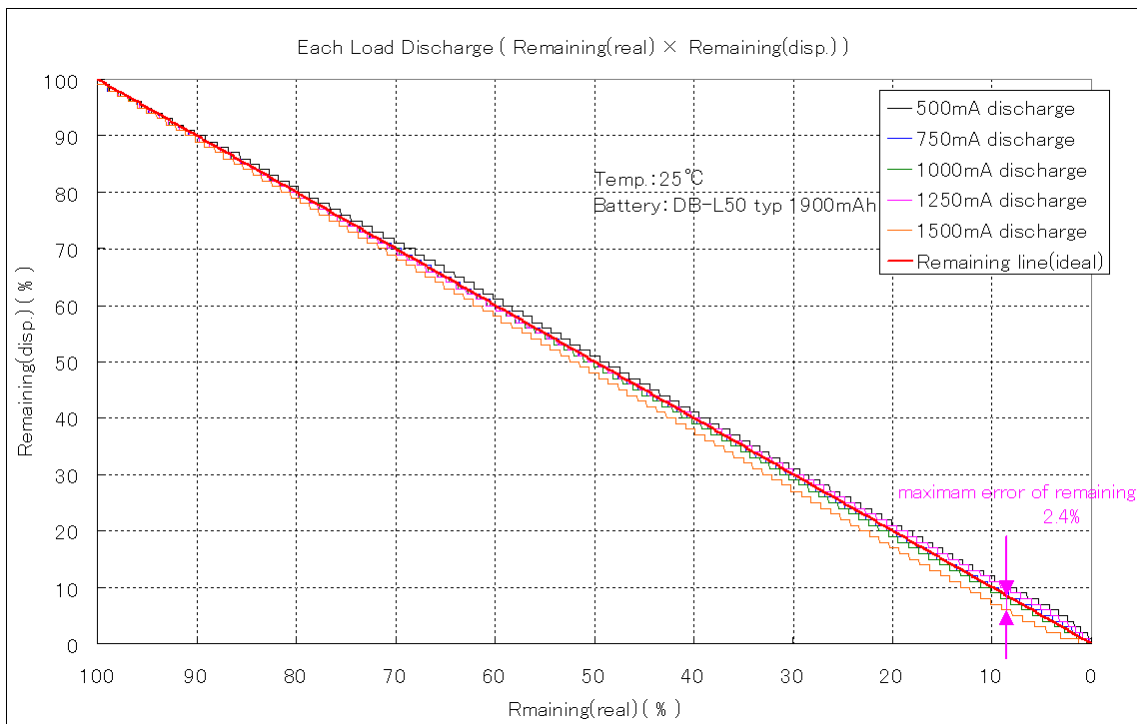

*Discharging test of 100% to 0% at room temperature. Shows discharging values of 500mA, 750mA, 1000mA, 1250mA and 1500mA. Red line is the ideal line and maximum error is 2.4%.

ON Semiconductor and the ON logo are registered trademarks of Semiconductor Components Industries, LLC (SCILLC). SCILLC owns the rights to a number of patents, trademarks, copyrights, trade secrets, and other intellectual property. A listing of SCILLC's product/patent coverage may be accessed at www.onsemi.com/site/pdf/Patent-Marking.pdf. SCILLC reserves the right to make changes without further notice to any products herein. SCILLC makes no warranty, representation or guarantee regarding the suitability of its products for any particular purpose, nor does SCILLC assume any liability arising out of the application or use of any product or circuit, and specifically disclaims any and all liability, including without limitation special, consequential or incidental damages. "Typical" parameters which may be provided in SCILLC data sheets and/or specifications can and do vary in different applications and actual performance may vary over time. All operating parameters, including "Typicals" must be validated for each customer application by customer's technical experts. SCILLC does not convey any license under its patent rights nor the rights of others. SCILLC products are not designed, intended, or authorized for use as components in systems intended for surgical implant into the body, or other applications intended to support or sustain life, or for any other application in which the failure of the SCILLC product could create a situation where personal injury or death may occur. Should Buyer purchase or use SCILLC products for any such unintended or unauthorized application, Buyer shall indemnify and hold SCILLC and its officers, employees, subsidiaries, affiliates, and distributors harmless against all claims, costs, damages, and expenses, and reasonable attorney fees arising out of, directly or indirectly, any claim of personal injury or death associated with such unintended or unauthorized use, even if such claim alleges that SCILLC was negligent regarding the design or manufacture of the part. SCILLC is an Equal Opportunity/Affirmative Action Employer. This literature is subject to all applicable copyright laws and is not for resale in any manner.